

ColdAIR

**ADIABATIC EVAPORATIVE COOLERS
WITH INLET AIR FILTRATION**

MOD: TC123F4/TC123F9/TC223F4/TC223F9

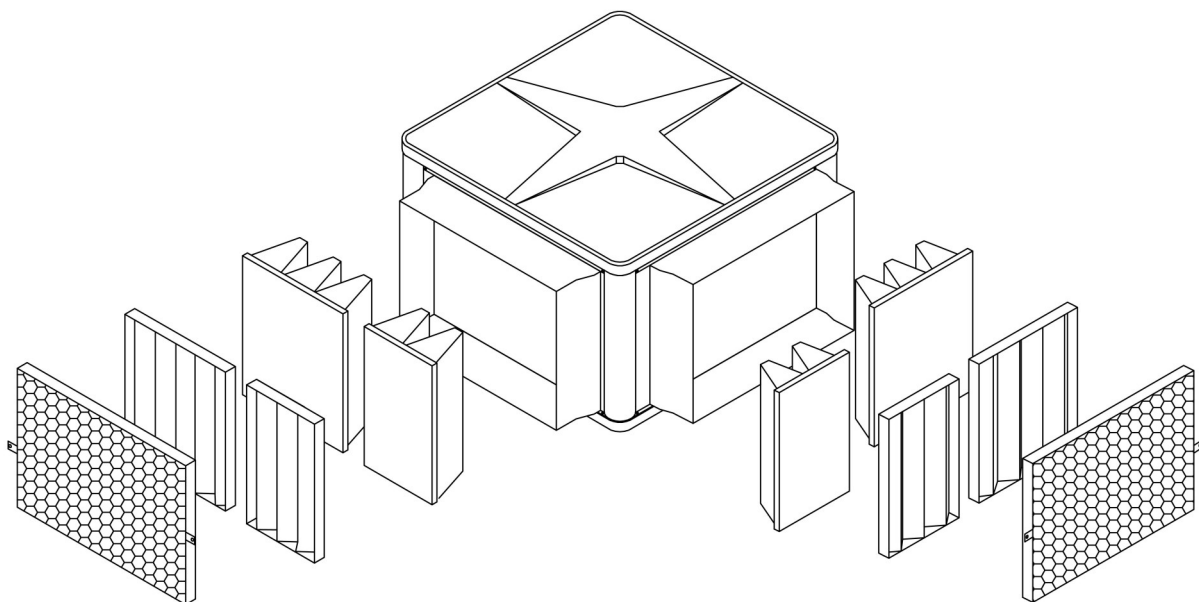

USE AND MAINTENANCE INSTRUCTIONS

INDEX

GENERAL INFORMATION	3
Preamble.....	3
SECTION 1 – CHARACTERISTICS	4
1.1 Presentation of the ColdAir Evaporative Cooler	4
1.2 Foreseen use	4
1.3 Machine identification data	5
1.4 Electrical boards	5
SECTION 2 – USING THE EVAPORATIVE COOLING UNIT	5
2.1 First start up	5
2.1.1 All models	5
2.1.2 TC model	5
2.2 Description use/program and operation	6
2.2.1 Remote Control Unit	6
2.2.1.1 Command descriptions	7
2.2.1.2 Signal descriptions and on-screen displays	7
2.2.2 Switching on the machine	8
2.2.3 Switching off the machine	8
2.2.4 Starting mode	8
2.2.4.1 Manual start mode	8
2.2.4.2 Automatic start mode	8
2.2.5 Settings	9
2.2.5.1 Setting time	9
2.2.5.2 Setting On/oFF periods	9
2.2.5.3 Reading a stored program	10
2.2.5.4 Modifying a stored program	10
2.2.5.5 Deleting a stored program	10
2.2.5.6 Setting temperature and humidity values	10
2.2.5.7 Locking/Unlocking remote command unit	11
2.2.6 Operating mode	11
2.2.6.1 Cooling	11
2.2.6.2 Ventilation	12
2.2.7 Operating faults	12
2.2.8 Bus System	12
2.2.9 Additional Functions	13
2.4 Functioning notes	14
2.5 Emergency situations	14
SECTION 3 – MAINTENANCE	14
3.1 End of season maintenance	14
3.2 Pre-season maintenance	15
3.3 Maintenance safety regulation	15
3.3.1 Clothing	15
3.3.2 On board signs	16
3.3.3 Residual risks	16
3.3.4 Technical assistance request	16
SECTION 4 – DISMANTLING	16
WIRING DIAGRAM	17
TECHNICAL FEATURES	18-19-20
DRAWING	21-22

GENERAL INFORMATION

PREAMBLE

Dear Customer,

We thank you for choosing an Impresind product and we would like to inform you that:

- The contents of this document are for information purposes only and are subject to modifications without notice;
- This manual cannot be partially or fully reproduced, transmitted, copied or stored in an archive system in any mechanical, magnetic, optical, chemical or other form or means without written authorization by Impresind S.r.l.

The workers using and maintaining the machine must be fully aware of its contents before the machine is placed in service.

If the manual is misplaced or damaged, immediately request a copy by contacting Technical Assistance Service at Impresind Srl, indicating the identification data of the plant shown on the machine identification plate and on the cover of this manual.

The machine is conforming to the following European Community Directives:

2006/42/CE	⇒	Machinery Directive
2014/35/UE	⇒	Low Voltage Directive
2014/30/UE	⇒	Electromagnetic Compatibility Directive
2009/125/CE	⇒	Ecodesign Directive

INFORMATION FOR REMOVAL OLD MACHINES



Attention:

This product falls within the scope of the Directive 2012/19/EU concerning the management of waste electrical and electronic equipment.

This device is for professional use only; so it must not be disposed of with domestic waste, as it is made of different materials that can be recycled at the appropriate structures.

This product is not dangerous for human health, but if abandoned in the environment negatively impacts on the ecosystem.

Read the instruction before using the device, and don't use this product for any use other than that indicated in the instruction.



This symbol means that this product is part of the legislation on the waste electrical and electronic equipment.

Abandonment in the environment of the device, or illegal disposals, is punishable by law.

SECTION 1 – CHARACTERISTICS

1.1 Presentation of the ColdAir Evaporative Cooler with inlet air filtration

To improve the summer microclimate inside a production unit, sales or other area, it is necessary to ventilate the environment with frequent changes of fresh, and possibly cool air. For large areas such as industrial buildings, an air conditioning system is usually not adaptable because the amount of energy required is very high, and the cooling effect is reduced by the exhaust air extraction system and by the many openings necessary for a normal activity.

Evaporative cooling systems, which cool the air using a natural principle, represent an optimal solution: the air passes through special wet evaporative panel, losing part of its heat, so reducing its temperature. The absence of refrigeration units reduces energy consumption to a minimum and enables great volumes of air. The models equipped with inlet air filtration increase the quality of the air supplied and improve the healthiness of the working environment.

1.2 Foreseen use

The evaporative cooler equipped with inlet air filtration can be installed in any environment where it is necessary to improve the microclimate, where the environment must be ventilated with frequent changes of filtered air fresh, and possibly cool air, such as:

- production buildings and craft facilities
- commercial premises and warehouses
- sport hall, gyms and similar premises



It is absolutely forbidden to make modifications to the machine and its destination of use.

IMPRESIND SRL declines all responsibility for any damages which may be, directly or indirectly, caused to exposed persons or property, due to improper use or use of the machine for different purposes other than the design purposes, incorrect installation, inappropriate power supply, different or changes to the installation environment from the one declared during order confirmation, grave deficiency of maintenance, unauthorized alterations and modifications, use of non-original spare parts, removal of the protection guards, inobservance of the instructions for use, negligence, etc.



*The machine must NOT be used for a different use than its designed use for any reason whatsoever or used in a different way than stated in this manual.
DO NOT install the machine in closed areas; the machine must be installed outside the area to be treated, except by specific approval of the manufacturer.
DO NOT lay weights on the machine*



DO NOT start-up the machine if it is not connected to its related air distribution system (ductwork). DO NOT start-up the machine if the filters are not installed.



*When the plant is operating, do not touch the fan – Mechanical danger.
It is forbidden to work on moving parts.*



It is absolutely forbidden to install Cold AIR evaporative cooling plants in potentially explosive environments.

1.3 Machine identification data

Machine identification data is shown on the warranty sheet supplied to the customer along with the other technical documentation, and on the machine identification plate.



If Technical Assistance or spare parts are required, always supply the machine model and serial number.

1.4 Electrical boards

Any electrical boards supplied by Impresind s.r.l. are manufactured according to CEI EN 60204-1:2018 regulations.



It is absolutely forbidden to make modifications to the electrical board.

SECTION 2 – USING THE EVAPORATIVE COOLING UNIT

2.1 First start up

For optimally using and functioning of the plant/machine it is necessary that, during the first start-up (in cooling mode), the fan runs at minimum speed and keeps it for at least one complete day. If this procedure is not observed, during the first day of functioning only, malfunctioning of the evaporative pads may occur resulting in water drops coming out of the ducts.

During the first start-up of your cooling system, an unusual odour may be detected.

When the evaporative panels start to get wet, they may emit a particular odour, which may be present for several hours. This odour is a characteristic of the treated cellulose material but it is not harmful.

Even the fan motor may present a “characteristic” odour for a short period, which is caused by initial heating and by any paint on the surface of the motor itself.

During first start-up, be sure of the right rotation of the fan (indicated with an arrow (adhesive plate) placed on fan body):

1. Take the machine top off by unscrewing the 4 corners screws.
2. Turn the machine on in ventilation mode
3. Look rotation must have the same direction of the arrows as shown.



4. If the fan should rotate in the wrong direction, it's necessary change the main switch power supply connections by exchanging L1 and L2 connections
 5. Look again.....rotation has the same direction of the arrow .
 6. Replace and fix the machine top.
- If at point 3), the fan should rotate in the right direction, go to point 6) avoiding point 4) and 5).



Check the tightness of the belt

As the latter, after the first few hours of operation, tend to loosen due to the elasticity of the rubber, correct tension must be restored, thus avoiding annoying noises and ensuring long life. To check the belt, proceed as follows:



Place a perfectly straight extruded bar on the two pulleys, by using a finger apply a light force on the middle of the belt and measure the distance between the flexed belt point and the bar. The distance should be between 1cm and 1,5cm.

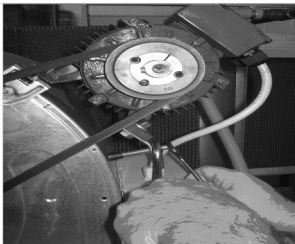

If the measured distance is higher or lower, it's necessary to tight or to release the belt by using the apposite screw.



Excessive tightness of the belt as well as reducing the life of the belt, may also cause deformations to the fan shaft and overload the bearings

Check, when checking the tightness of the belt, that the fan bearings do not leak liquefied grease: this, together with the excessive temperature of the bearings ($>60^{\circ}\text{C}$), detectable by touch, is a symptom of defects.

Check that the power input value of the electric motor fall within the operating limits shown on the rating plate. If the value is higher, this is normally the result of overestimating the pressure drop in the system, and must be corrected by adjusting the equalizing dampers and/or the transmission ratio by changing one of the two pulleys.

2.2 Description use/program and operation

2.2.1 Remote Control Unit (display)

The cooling units are equipped with a remote control panel, which enables the user to manage all the functions.

This panel contains a logical unit which enables several functions necessary for good operation of the cooling unit.



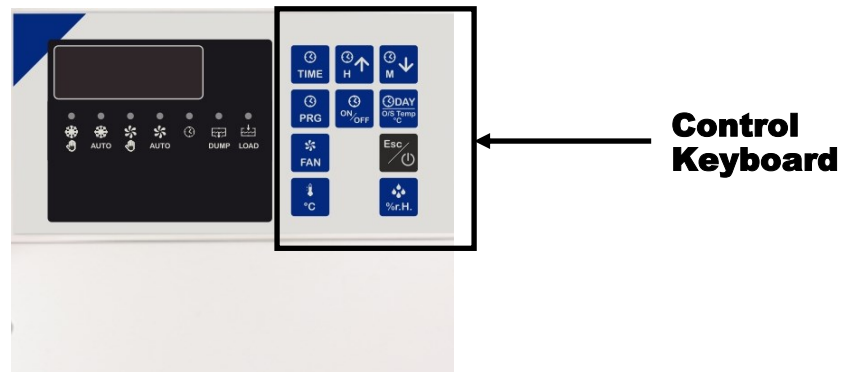

2.2.1.1 Controller Description





 Pressed once during setting On/off periods, and exits menù.
Keeping pressed more than 3 sec. if control unit is locked , ora temporary unlocked.

 Displays th current Fan speed (F1,F2,F3, ecc ecc)

 Pressed once, gets into program selection (PTim menù) or into On/Off periods setting, and it has enter fuction.

 Select operating mode: Cooling, Ventilation, ecc ecc

 Select/changes days

 Pressed once, gets into time selection (Time menù) and setting time

 Varies fuction, according to the selected menù:

- changers hours (Time menù)
- changers (increase) parameter value (PAR menù)
- changers (increase) Fan speed (Fan menù)
- keeping pressed with “M” gets into PAR menù

 Varies fuction, according to the selected menù:

- changers minute (Time menù)
- changers (decrease) parameter value (PAR menù)
- changers (decrease) Fan speed (Fan menù)
- keeping pressed with “H” gets into PAR menù

 Shows the temperature detected.
Keeping pressed more than 5 sec., set the temperature set-point.

 Shows the humidity detected.
Keeping pressed more than 5 sec., set the humidity set-point.

2.2.1.2 Signals descriptions and on-screen displays

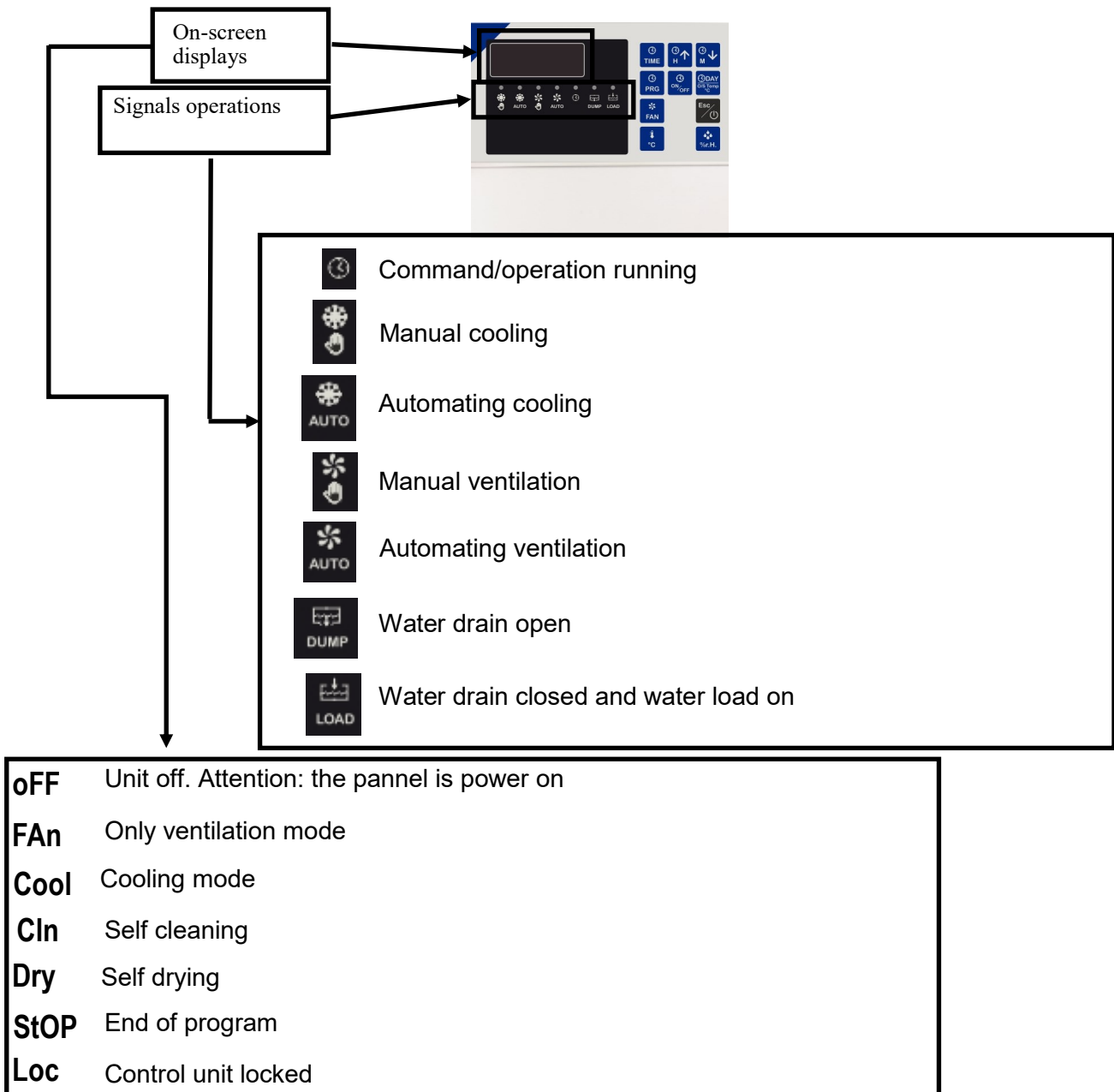

2.2.2 Switching ON

Keep key pressed until the display shows a fuction mode

2.2.3 Switching OFF

Keep key pressed until the display will show off

2.2.4 Starting mode

2.2.4.1 Manual start mode

With the machine switched on press the key untile the led of the operation require is on

2.2.4.2 Automatic start mode

With the machine switched on, press key  until led of the corresponding automatic mode is on.

2.2.5 Setting

2.2.5.1 Setting the correct time

Keep the key pressed  until display shows "Time"

On the display shows the setted curent time.

When you are modifyng the time the simbol  blinking

Press the key  for set the day of the week

Press the key  to insert the correct hour

Press the key  to insert the correct minutes

To get back wait 5 sec., or press key 

2.2.5.2 Setting automatic On/Off periods



Keep the key  pressed until display shows "PTim".

On the display shows the first memory position.

If the position is not free press  until appears on the display -- : --.

When you are modifying, simbol  blinking

Press the key  for set the day of the week

Press the keys   for set the time

Press the key  for select the correct fuction mode

Press the key  for save the program

Press the key  for exit of the menù

2.2.5.3 Reading a stored program

Press the key  and the display will show the first space memory.

Repeat the operation to view the next programs

Press key  for exit

2.2.5.4 Modifyng a program

Press the key  and the display will show the first space memory.

Repeat the operation until view the program to be changed

Act on the keys     for to modify the program parameters

Press the key  form confirm

Press the key  for exit

2.2.5.5 Deleting a program

Press the key  and the display will show the first space in memory.

Repeat the operation until view the program to be deleted.

To delecte the program, press and keep pressed the key  until view “ - - : - - “.

To delecte all the program repeat the operation until will view “EALL”



Press the key  for exit

2.2.5.6 Setting the Set Point values:



Preset Set Point values:

Temperature: 26°C 

Relative Humidity: 75% 

Keep press the key  or  until will show “SP”.











The display shows the set point value and teh simbol  blinking.

Use the keys   for change the Set Point value

Press the key  for confirm .

2.2.5.7 Locking/Unlocking remote control unit

It is possible to lock or unlock the control unit by changing the “HL” parameter.
To change this parameter, proceed as follows:

- keep pressed together the keys  and  until the display shows “PA”
- press key 
- press key  or  to find the parameter to be changed (HL)
- press key 
- press keys  or  to change
- press keys  to confirm
- press key  to exit

Parameter HL:

- YES= Locking
- NO = Unlocking

For a temporary unloked (15 sec) press key  until display show “OFF”

2.2.6 Operating mode

2.2.6.1 Cooling



Press key  to choose the cooling mode desired (manual ora automatic)

In the cooling manual mode, the machine will immediately the cooling cycle; the display show “COOL”. In the cooling automatic mode, the cycle will start only the presect of an a correct program.

If inside the building there is a relative humidity value (+5%) the the set point valure, the machine temporaly suspends the cooling function.

The same will happen in the event of a temperature inside the buliding that is lower (-1.5°C) that the set point value.

It is possible to change the fan speed by key 

The selection of the fan speed by keys  

For information of the automatic fan speed (AUTO) see paragraph: 2.2.6.2 Ventilation Mode

To ensure a longer life of the evaporative panels, have been presect specific activities:

- water change cycle (ever 4 hours)
- post-cooling panel drying cycle (duration 5 minute)
- panel wash cycle (duration 8 minute)

2.2.6.2 Ventilation mode

Press key  to choose the desired ventilation mode (automatic or manual)

In ventilation manual mode, the machine will immediately ventilation. In ventilation automatic mode, machine will be activated only in the presence of correct program.

As in the cooling mode, also for the vantilation mode it will be possibile to act on the fan speed by the key



Press the keys   for change the fan speed

Press key  for exit

The automatic fan speed (AUTO) allows of the fan speed as the temperature detected inside the building varies as follows:

- T inside= SP+4°C: max. speed
- T inside= SP+2°C: med. speed
- T inside= SP : min. speed
- T inside< SP : fan will torn off

T increase the life of the panel, a wash cycle is also preset for the ventilation mode. This preselect functions is activated automatically whn the machine is turned off and/or after 16 hour of operation.

2.2.7 Operating anomalies:

In the evente of an anomaly and/or malfuction, the control unit shows alphanumeric code. These code identify the type of error and/or failure, and facilitating the possible solution.

The maid error/fault codes and possibile solutions are listed below:

- EE : EEprom defective—turn off and on the control unit
- EE/: communication error between logic board and power board. Check connection.
- EA: level switch—possible accumulation of the dirt around the valve or level switch. Tunr off and on the control unit
- EAP: pressure switch alarm, dirty evaporative pads. Replace evaporative pads
- Etc: clock error—reset correct time
- Er8 & E2: probe error—communication error with on or more probes

If the problem persists, proceed as follows:

- disconnect power supply
- disconnect water supply





2.2.8 Bus System

The unit is equipped with an electronic interface by bus system and/or network system. Various optionals and alternative control unit are available on the catalog. For more information contact Impresind Srl

2.2.9 Optional Functions

The new ColdAir coolers allow the activation of a series of interesting innovative optional functions, designed for greater energy savings and with particular attention to greater conservation of water resources.

To activate one or more functions, the relative parameters must be enabled, as follows:

- keep pressed together the keys  and  until the display shows "PA"
- press key 
- press key  or  to find the parameter to be changed

Each function is distinguished by a dedicated parameter. The list and its description are given below:

OCb: defines the optional pump cut-off function. This function, which can be activated only if the appliance is equipped with an external probe (optional), rationalizes the operation of the water supply pump according to the external temperature. To enable it select "YES"

OCU: Defines the optional function of Humidity-Plus. This function chokes the operation of the water feed pump near the maximum permissible humidity percentage. The parameter can assume the following values: 0 (function disabled), 1 (partialized at 10%), 2 (partialized at 20%), etc etc... Up to a maximum value corresponding to 5 (partialized at 30%)

OCr: Defines the optional Water-Save function. This function, which can only be activated with the appliance set to AUTOMATIC, anticipates the switching off of the water supply pump with respect to the machine switch-off time. It therefore allows better management of the water present in the collection tank, reducing (or even eliminating) the waste of water discharged at the end of the automatic cooling cycle. The parameter can assume the following values:

- 0 - function deactivated
- 1 - pump switch-off 10 min earlier than the end of the automatic cooling cycle
- 2 - pump switch-off 20 minutes earlier than the end of the automatic cooling cycle
(parameter recommended by Impresind)
- 3 - etc etc

Up to a maximum settable value of 9, which corresponds to an early switch-off of the pump of 90 minutes, with respect to the end of the automatic cooling cycle.

2.4 Notes on operation

An Evaporative Cooler works on the basis of an important principle: It introduces large quantities of cool air into the environment and removes the warm and stale air through openings (doors, windows, etc.). **COLD Air models equipped with inlet air filtration** further improve the microclimate of the environment, by purifying the air before it is cooled and the introduced into the environment.

COLD & PURIFIED AIR IN = WARM & STALE AIR OUT

The system operates at the highest efficiency if it is able to eject all the air introduced into the building. The ideal condition is to place the air diffusers away from openings (windows, doors, etc.) so that the air flow through the space while cooling it.

Never close the openings: if they are closed, no changes of air will occur, consequently reducing the cooling effect and increasing the relative humidity level inside the building.

To optimize the system efficiency, approximately 0,5 m² of openings every 1000 m³ of air supplied should be guaranteed (refer to the project data).

Typical of the evaporative cooling system, the drier the outside air, the greater the cooling capacity that can be achieved by the system. Your evaporative cooling system will not operate at its maximum efficiency during high humidity days, but it will still reach an efficient cooling level.

In areas with high humidity, the evaporative cooler must be over-sized in order to grant higher capacity. It is essential that the whole cooling system is designed based on the local climatic conditions. During days when the relative humidity level is closed to or above to 70%-75%, the Cooling Mode is not operated and the unit switches to Ventilation Mode. **The cooling efficiency of a system depends** on various factors: the cooling unit efficiency, the air ducts design, the installation quality, the building conditions.

During normal operating conditions in cooling mode, the evaporation process leaves mineral salts accumulation and solid residue in the discharge water, this water is **NOT POTABLE**.

2.5 Emergency situations



In case of emergency immediately turn the machine off and cut off the electrical circuit through the omnipolar isolator switch, identify and solve the problem by checking the causes that originated it. Contact a licensed technical service center.



It is absolutely forbidden to use water to put out fires. Use exclusively powder or CO2 extinguishers

SECTION 3 – MAINTENANCE

We recommend annual service to the system to maintain it in perfect operation conditions. Before the machine start-up the equipment should be checked to make sure it works properly.

3.1 End of season maintenance

- Cut power supply off through the main isolator-switch.
- Close the water supply.
- Empty the water supply system to avoid bursts due to icing.
- Take the machine top-cover out.
- Check and clean any waterways and the water supply and distributor .Clean any debris in the water pump. **Clean the water filter (view information sheet).**
- Fully clean the tank of the unit. Use a mild detergent, not a solvent because it may reacts with the plastic materials.
- Check conditions of filters and cover-rain grids
- Replace and fix well the machine top-cover using the bolts supplied.
- Apply the winter protection cover (if included in the supply) on the unit. Fixing very easy , by using the elastic cords of the cover

3.2 Pre-season maintenance

- Cut power supply OFF using the main isolator-switch installed on-board the Machine.
- Remove (if purchased, because not included in the supply) the winter protection cover, check for any damage, clean it and store it in a protected place. When cleaning, use a mild detergent, not a solvents, because it may react with the cover material.
- Remove the machine top cover.
- Clean the tank. When cleaning, use a mild detergent, not a solvents, because it may react with the material.
- Check the tightness of the belt (*) (see par.2.6.2). In the presence of signs of wear or beginning of fraying the belt must be changed.
- Check the evaporative pads and clean them; in case, replace with new ones. Repeat the same operation on any filter (**) and any anti-rain grid.
- Check and clean any waterways and the water supply and distributor. Remove any debris in the water pump. **Clean the water filter (view the specific information sheet).**
- Check electrical wiring conditions.
- Turn the power supply ON using the main isolator-switch installed on-board the machine.
- Open the water supply. Start the Mahine in Cooling Mode and check that the discharge valve closes and that the water fills the tank up until the water inlet valve stops.
- Check that the water is evenly distributed over all evaporative pads.
- Check that the discharge valve is working properly; make sure that it opens within 5 minutes after the Machine is turned-off.
- Check if there is any water leakage, from the tank or from the supply piping.
- Put the top cover back on and make sure it is properly fixed.

(*) During the season, when the Machine is in operation it is advisable to check the belt tightness monthly.

(**) During the season, when the Machine is in operation, check frequently the state of filters . Each Machine is equipped with a pressure switch kit, pre-set at 200Pa. If correctly connected, it can detect when filters are clogged and no longer efficient

IMPORTANT DO NOT START THE MACHINE WITHOUT FILTERS !!!



The manufacturer does not assume any responsibility or is liable for any guarantee due to damage caused by non-observance of prescriptions, any non-conform installation and in the case of improper use of the Machine by the final user.

3.3 Maintenance safety regulations

3.3.1 Clothing

The personnel charged to machine maintenance must not wear clothing with large sleeves, laces or belts, which may cause danger. The personnel must also wear individual protection devices conforming to the laws and regulations in force.



The maintenance personnel must be professionally qualified. Before carrying out any maintenance operations, read carefully this section of the manual. For any necessity, contact Impresind Srl After Sales Service. Impresind Srl is not responsible for any damage or malfunctions due to lack of respect of the indications contained in the present section of this manual.

During maintenance operations, place clearly and easily visible a sign stating "Work in Progress" on all access areas to the department. Record all maintenance operations carried out on an appropriate register, making sure to state: date, time, type of intervention performed and the name of the person.



The personnel charged to maintenance that use any solvents must be equipped with individual protection devices (safety glasses, filter masks, gloves) suitable for contact with the solvent used. When using solvents it is strictly forbidden to smoke and use open flames. After use, ventilate the building to help any residual vapours to leave.

It is forbidden to:



***Leave any flammable materials near to electrical panels.
Operate on the electrical equipment before cutting power supply off.
Operate on any part of the unit before the plant did stop.
Operate with safety systems deactivated or removed from the equipment.
Deactivate or evade the alarm signals.***

3.3.2 On board signs



DANGER: Risk of electric shock



MOVING MACHINERY

3.3.3 Residual risks



Pay attention to fan movement. Do not introduce arms or limbs. – Mechanical danger



It is forbidden to use water to clean electro-mechanical components – Electrocutation danger



***It is absolutely forbidden to use water to put out fires.
Use exclusively powder or CO2 extinguishers***

Once maintenance is terminated, before switching back the equipment on and starting-up the plant, perform a complete check for any tools and/or materials of any nature left near to or inside the unit and above all near to any moving mechanisms.

3.3.4 Technical assistance request

For any technical assistance intervention, contact the installer or a licensed technical service center.

To know the nearest licensed technical service center, please contact Impresind srl.

SECTION 4 – DISMANTLING

In case of dismantling and disposal of the plant, all material concerning the plant must be collected and sent to the appropriate collection and disposal centres of companies specialized in the disposal sector.



***Dismantling of the plant must be carried out by specialized personnel, equipped with suitable equipment and personal individual protection devices.
Do not smoke and do not use open flames.***

WIRING DIAGRAM

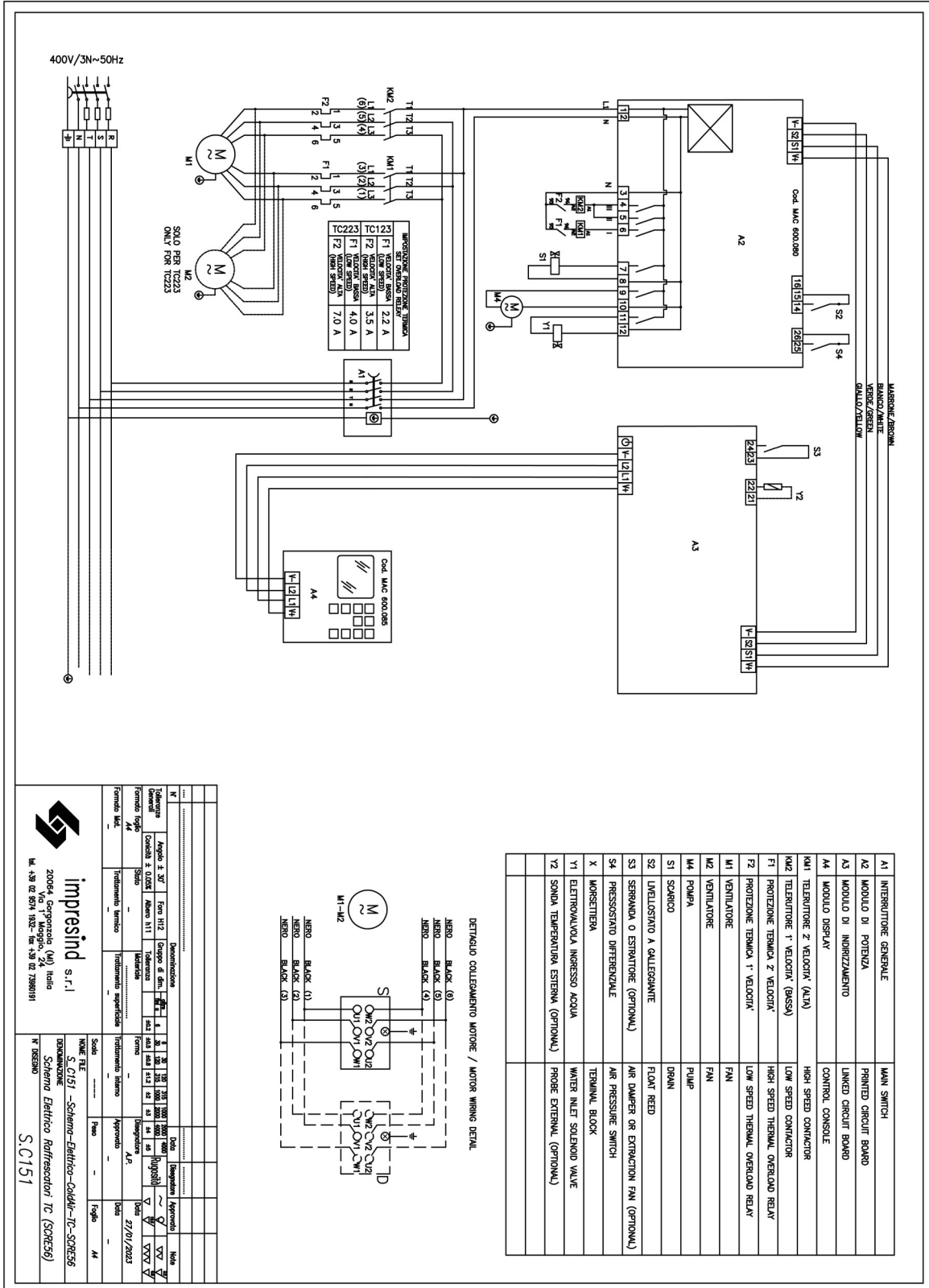

TC123 & TC223



TECHNICAL CHARACTERISTICS

Model		TC123F4	TC123F9	TC223F4	TC223F9
Air flow Speed min / max	m³/h	6500 / 10000	6500 / 10000	12000 / 19000	12000 / 19000
Power supply	V/~Hz	400V/3N~50Hz	400V/3N~50Hz	400V/3N~50Hz	400V/3N~50Hz
Absorbed current	A	3.5	3.5	7	7
Power consumption	kW	1.6	1.6	3.2	3.2
Water consumption (*) (average)	lt/h	43	43	64	64
Dimensions WxDxH	mm	1600x1600x1050	2100x2100x1050	2050x1600x1050	2550x2100x1050
Water supply Diam.	in	3/8	3/8	3/8	3/8
Water drain Diam.	mm	63	63	63	63
Air duct dimensions	mm	465x395	465x395	850x470	850x470
Weight Empty / Full	kg	180 / 210	210 / 240	270 / 300	310 / 340
Fan type		Centrifugal	Centrifugal	Centrifugal	Centrifugal
Max lenght of ducts		5 m + 1 elbow	5 m + 1 elbow	8 m + 1 elbow	8 m + 1 elbow
Evaporative pads					
Thickness	mm	100	100	100	100
Area	m²	2.7	2.7	3.4	3.4
Saturation efficiency	%	88	88	88	88
* = Test conditions		Outdoor Temperature: 33°C Outdoor Relative Humidity: 60%			
Noise (sound pressure level) min/max Free space (4mt distance)	db(A)	53/65	52/64	55/70	54/69

AIR FILTERS - TECHNICAL CHARACTERISTICS

FILTERS DESCRIPTION	PICS	THECNICAL DATA
<p>FILTERING-CELLS SYNTHETIC ONDULATE</p>		<p>Frame: galvanized steel Filter: synthetic Efficiency: G4 Eurovent: EU4 Arrestance: 90% Max Pressure: 250 Pa</p>
<p>POKET FILTERS IN MICRO FIBERGLASS</p> <p>ONLY FOR MODELS TC123F9 AND TC223F9</p>		<p>Frame: plastic Filter:: micro fiberglass Efficiency: F8-F9 Eurovent: EU8-EU9 Arrestance: 90%-95% Max Pressure: 250 Pa</p>

INFORMATION ABOUT MAINTENANCE: FILTERS AND COOLING PADS

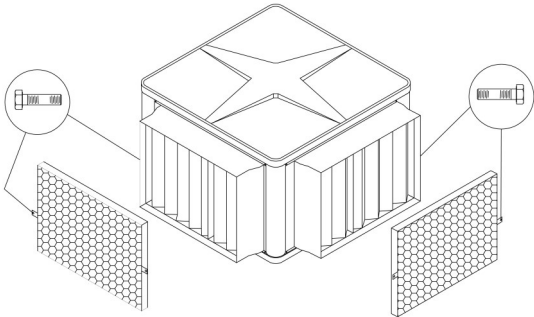
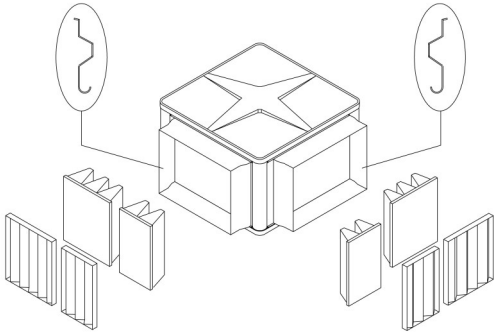
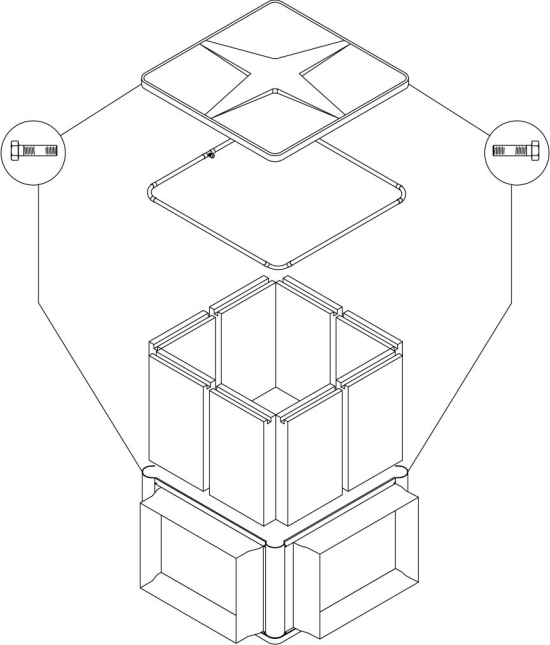
<p>REMOVE THE ANTI-RAIN GRIDS BY UNSCREWING THE FIXING SCREWS</p> <p>ALWAYS CHECK THE CORRECT ORIENTATION (see labels on the grids)</p>	
<p>PULL-OUT THE FILTERS BY REMOVING THE METALLIC CLIPS</p>	
<p>REMOVE THE TOP COVER BY UNSCREWING THE FIXING BOLTS</p> <p>REMOVE THE WATER DISTRIBUTOR</p> <p>PULL-OUT THE COOLING PADS</p>	

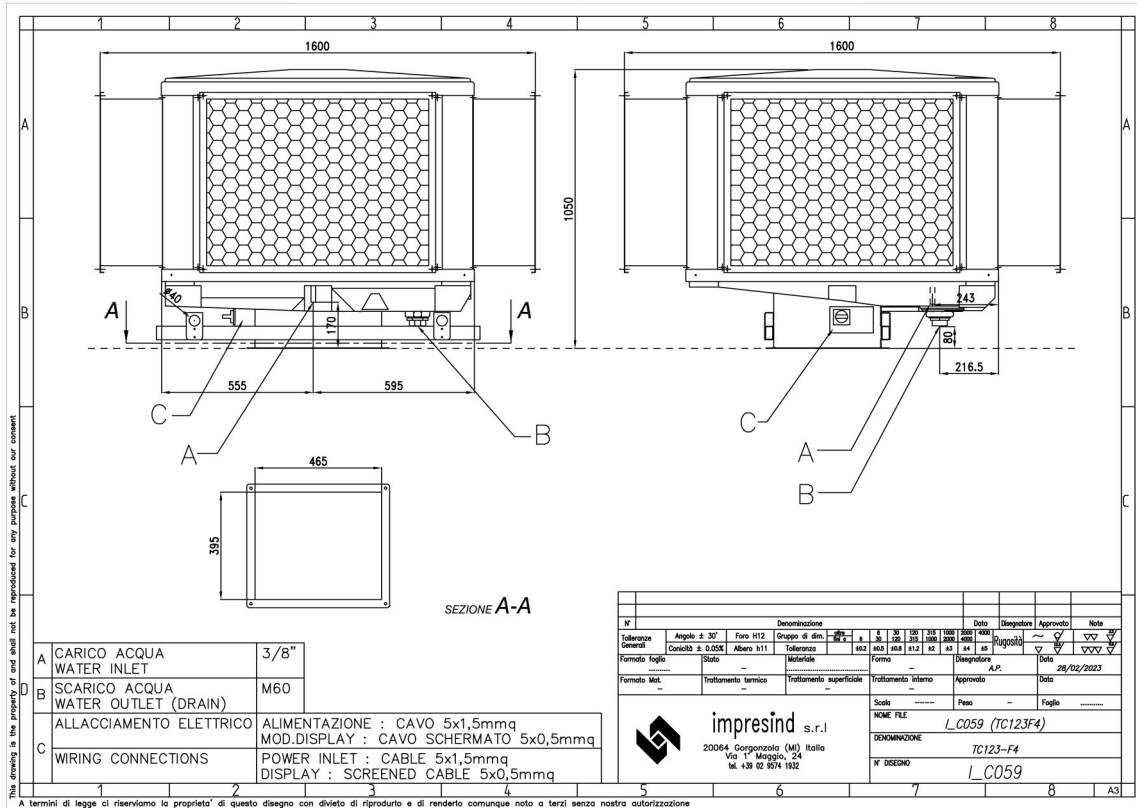
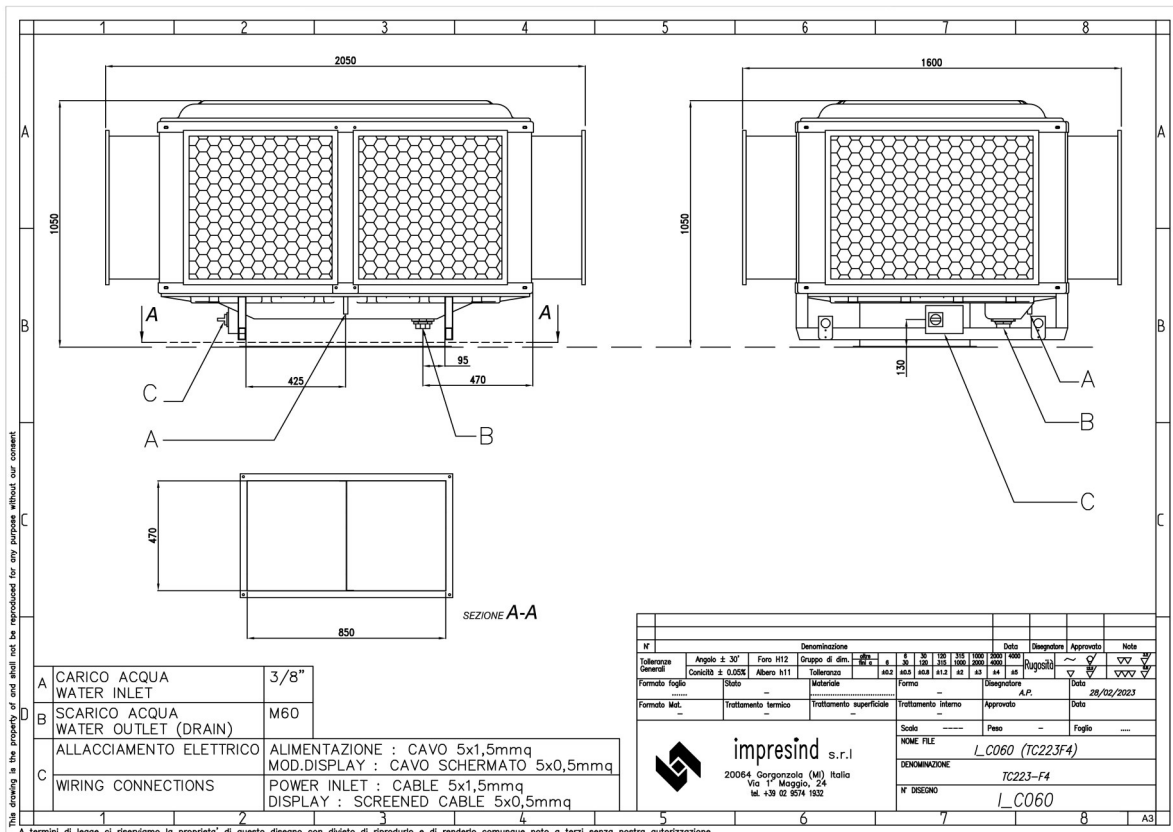
DRAWING
TC123-F4

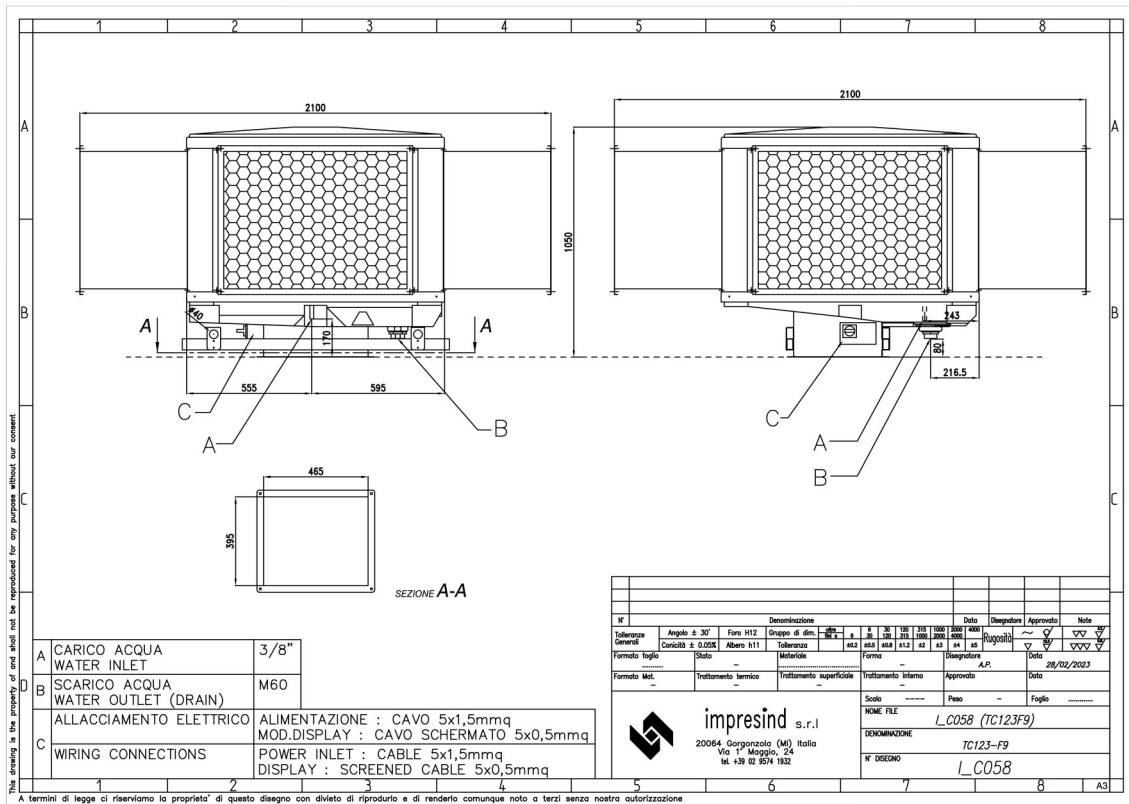
TC223-F4

TC123-F9

TC223-F9
